

**Small Cassette Installation**

**Step 1: Install the Brackets**

**OUTSIDE MOUNT:** Install above the wood trim or window frame. Use the rear bracket holes. Care should be taken to ensure all brackets are level.

**INSIDE MOUNT:** Install inside the window frame. Use the top bracket holes.

Install the two outside brackets first, no further than 2" in from each end of the headrail. Install the remaining brackets evenly spaced in increments of 24" or less. Care should be taken to ensure all brackets are level.

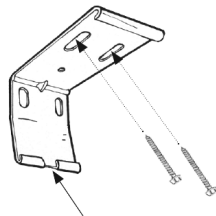
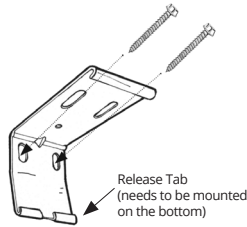

Release Tab  
(needs to be mounted on the bottom)

**Step 2: Mount the Headrail**

Place the back lip of the headrail on the bottom lip of all brackets.

Push the front of the headrail firmly upwards, then roll the headrail up and towards the window opening until it snaps into the brackets.

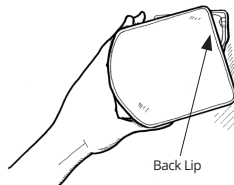

Back Lip

**Step 3: Install Cord Tensioner**  
**IMPORTANT**

In compliance with national safety regulations shades will not operate unless the cord tensioner is installed correctly! After the shade is installed, the cord tensioner must be secured to the wall.

1. Position the tensioner as close to the shade as possible without interfering with the shade.
2. The tension on the cord/chain should be loose enough to allow free movement, but tight enough not to allow a hazardous loop.



**Large Cassette Installation**

**Step 1: Install the Brackets**

**OUTSIDE MOUNT:** Install above the woodwork or window frame. Use the rear bracket holes. Care should be taken to ensure all brackets are level.

**INSIDE MOUNT:** Install inside the window frame. Use the top bracket holes.

Install the two outside brackets first, no further than 2" in from each end of the headrail. Install the remaining brackets evenly spaced in increments of 24" or less. Care should be taken to ensure all brackets are level.

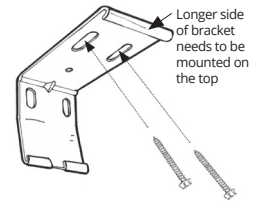
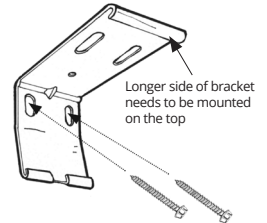

Longer side of bracket needs to be mounted on the top

Longer side of bracket needs to be mounted on the top

**Step 2: Mount the Headrail**

Place the back lip of the headrail on the bottom lip of all brackets.

Push the front of the headrail firmly upwards, then roll the headrail up and towards the window opening until it snaps into the brackets.

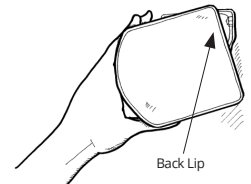

Back Lip

**Step 3: Install Cord Tensioner**  
**IMPORTANT**

In compliance with national safety regulations shades will not operate unless the cord tensioner is installed correctly! After the shade is installed, the cord tensioner must be secured to the wall.

1. Position the tensioner as close to the shade as possible without interfering with the shade.
2. The tension on the cord/chain should be loose enough to allow free movement, but tight enough not to allow a hazardous loop.



**Installation**

**Step 1: Before Installing**

Your new Shades of Elegance™ roller shades are wrapped at the factory with two layers of paper. The final inner paper wrap around the center of the shade is to protect the shade from damage and fingerprints during installation. Only pick up the shade with the paper wrap and leave it on until the shade is fully installed up in the window.

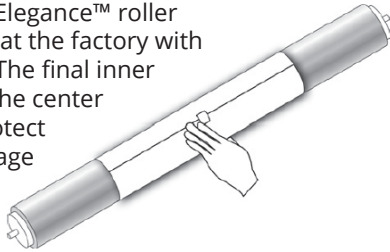

**Universal Brackets**

Shades of Elegance™ Clutch Roller Shades features a tabbed and spring loaded pin-end bracketing system to be used with all applications.

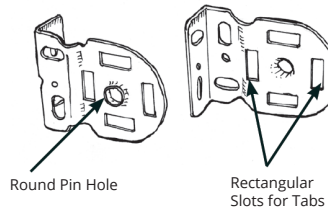

**Step 2: Mounting the Brackets**

Make sure that both brackets are perfectly level and fasten using two screws for each bracket.

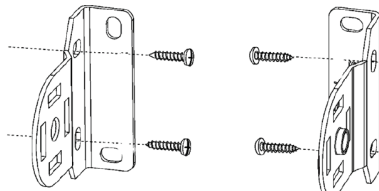

**INSIDE the Window Frame**

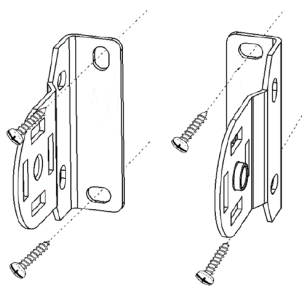

**To the Wall or Front of the Window Molding**

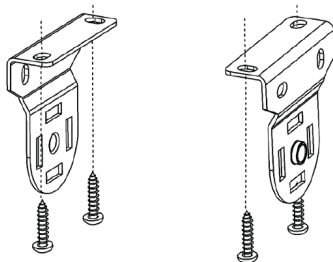

**To the Ceiling or Top of the Window Frame**

**Installation, continued**

**Step 3: Installing the Shade**

1. Insert the end of the shade with the pin into the round hole of the bracket so the end pin is depressed.
2. Keeping the pin end secured in its bracket, insert the tabs on the clutch into the rectangular slots. Once the two tabs are through the holes, gently pull downward on the clutch until the tabs are locked securely to the bracket. The bottom of the clutch should always point straight down.
3. Remove the paper wrapped around the shade mentioned in Step 1.

**Step 4: Install Cord Tensioner**

**IMPORTANT:** In compliance with national safety regulations **shades will not operate unless the cord tensioner is installed correctly!** After the shade is installed, the cord tensioner must be secured to the wall.

1. Locate the tensioner as close to the shade as possible without interfering with the shade.
2. The tension on the cord/chain should be loose enough to allow free movement, but tight enough not to allow a hazardous loop.



**Installing Decorative Shade Pulls**

To avoid damage to the shade during shipping, the factory does not attach decorative shade pulls. When a metal decorative pull is ordered, a hole is predrilled through the bottom hem and marked with a plastic tag. Remove the plastic tag and insert the screw through the hole from the back. Screw into the metal decorative pull on the front of the shade using a phillips head screwdriver.

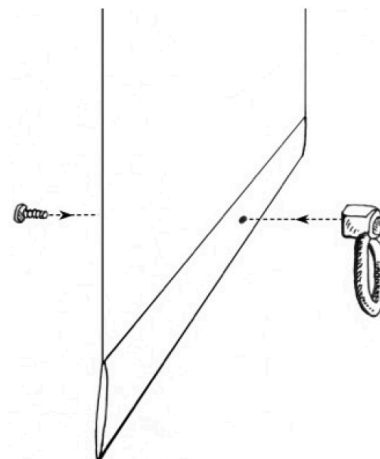

Installation Instructions for  
**Shades of Elegance™  
 Spring Roller Shade**

**Before Installing**

Your new Shades of Elegance™ roller shades are wrapped at the factory with a layer of paper. The paper wrap around the center of the shade is to protect the shade from damage and fingerprints during installation. Only pick up the shade with the paper wrap and leave it on until the shade is fully installed up in the window.

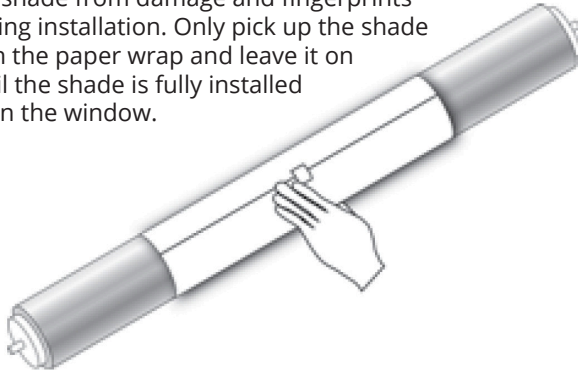

**Bracket Configurations**

Brackets for Standard Shades

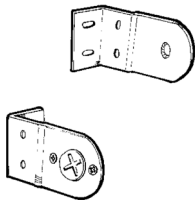

Brackets for Reverse Roll Shades

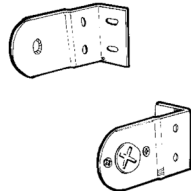

**Standard Shade Instructions**

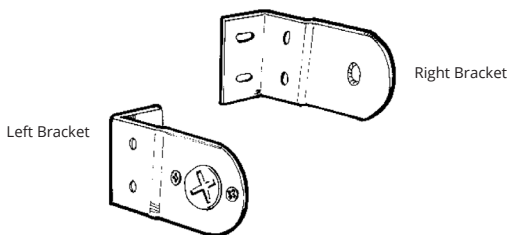

**Mounting the Brackets**

- The mounting brackets for standard roller shades are suitable for side, top, or wall mounting. Make sure that the brackets are perfectly level with each other.
- For an INSIDE MOUNT allow 1/2" clearance between the top of the frame and the top of the fully rolled shade.
- Always allow a small amount of play between the brackets and the roller ends to ensure proper roller function.

**Standard Shade Instructions, continued**

**Installing the Shade into Brackets:**

Slide the spring end into the the left bracket (Diagram A) and then fit the end with the pin into the left bracket (Diagram B).

After the shade is completely installed, carefully remove the paper wrap.

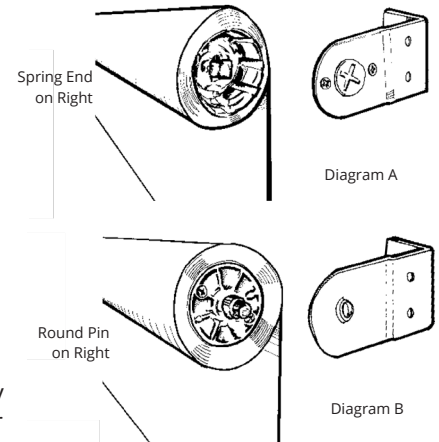

**Reverse Roll Instructions**

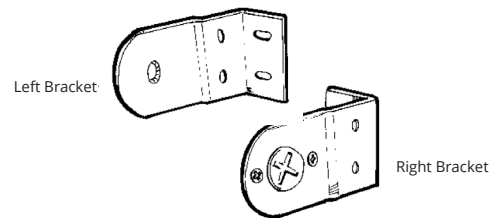

**Mounting the Brackets**

- The mounting brackets for reverse roller shades are suitable for side, top, or wall mounting. Make sure that the brackets are perfectly level with each other.
- For an INSIDE MOUNT allow 1/2" clearance between the top of the frame and the top of the fully rolled shade.
- Always allow a small amount of play between the brackets and the roller ends to ensure proper roller function.

**Installing the Shade into Brackets:**

Slide the spring end into the the right bracket (Diagram A) and then fit the end with the pin into the bottom of the left bracket (Diagram B).

After the shade is completely installed, carefully remove the paper wrap.

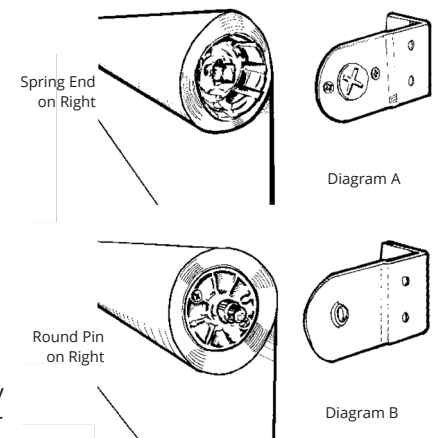

## Adjusting Tension

Adjust or set the tension by turning the spring end adjust bracket clockwise with a standard screwdriver. It is recommended to make only 1/4 to 1/2 turns until the desired tension is reached.

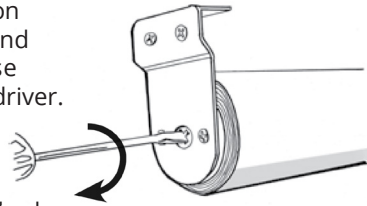

**IMPORTANT:** Be sure to use a Standard (Flat Head) screwdriver as a Phillips Head can strip the plastic adjustment screw.

For an INSIDE MOUNT shade, roll the shade up by hand and replace it in the brackets. Repeat until the proper tension is reached.

## Removing Shade from Brackets

For an OUTSIDE MOUNT shade, depress the pin end until the shade releases from the bracket.

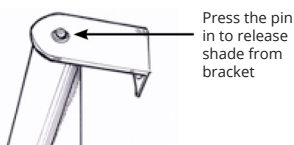

For an INSIDE MOUNT shade, insert a thin blade flat head screwdriver between the shade barrel and the end bracket up against the pin. Depress the pin until the shade releases from the bracket.

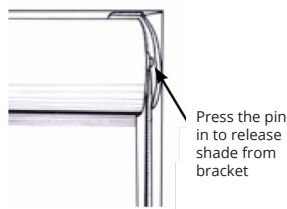

## Installing Decorative Shade Pulls

### Decorative Metal Pull

To avoid damage to the shade during shipping, the factory does not attach decorative shade pulls. When a metal decorative pull is ordered, a hole is predrilled through the bottom hem and marked with a plastic tag. Remove the plastic tag and insert the screw through the hole from the back. Screw into the metal decorative pull on the front of the shade using a Phillips head screwdriver.

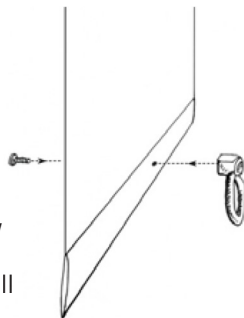

### Decorative Pull Ring or Tassel

To attach a shade pull, locate the center of the bottom rail and mark lightly with a pencil. Use an awl to punch a hole at the pencil mark. Wrap the cord loop around the screw of the Higbee Button. Screw the Higbee Button into the bottom rail through the fabric until the slot on the back of the button is at the bottom of the shade, the cords should hang straight down.

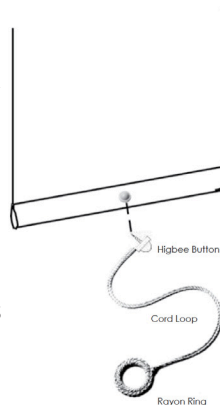

## Shade Maintenance

### Leveling a Crooked Shade

1. Pull down shade until roller is exposed. Do not pull further to avoid pulling cloth off roller.
2. Stick a 5" strip of masking tape into the roller at opposite side from where it is going crooked. Place as close to edge as possible.
3. Roll up shade. If it is still going crooked:
  - A. If shade is still crooked to the same side, add another strip of tape on top of the first one and repeat.
  - B. If shade is crooked to the opposite end, tear off about 1" from tape and repeat

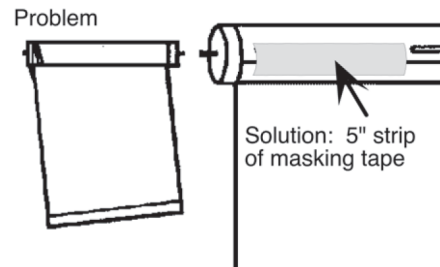

**REMEMBER:** After making above correction, your hand is still the best guide to rolling a shade straight. Watch the end of the roller as you roll up shade to see if shade is going even.

### Wrinkled Shade

Light wrinkles in a shade can be removed by lowering the shade and leaving in this position for five to seven days. The wrinkles will smooth out from the warmth of the sun.

## Limited Lifetime Guarantee

**Horizons Window Fashions warrants that its Horizons products—properly installed in a residential dwelling—will be free from defects in materials and workmanship for as long as the original purchaser owns the product.**

All fabric colors tend to lose their original intensity over time, and pull cords eventually wear out. This is considered normal wear and tear and is not covered by this guarantee. Abuse and misuse are not covered. Color lots vary and may not exactly match a previously ordered product. Repair is the purchaser's sole remedy under this guarantee.

**This guarantee does not cover incidental or consequential damages, freight, installation, or service calls (trip charges).**

## Shade Maintenance

### Leveling a Crooked Shade

1. Pull down shade until roller is exposed. Do not pull further to avoid pulling cloth off roller.
2. Stick a 5" strip of masking tape into the roller at opposite side from where it is going crooked. Place as close to edge as possible.
3. Roll up shade. If it is still going crooked:
  - A. If shade is still crooked to the same side, add another strip of tape on top of the first one to and repeat.
  - B. If shade is crooked to the opposite end, tear off about 1" from tape and repeat

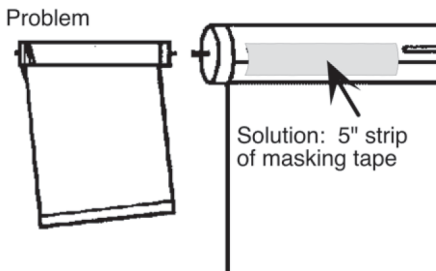

**REMEMBER:** After making above correction, your hand is still the best guide to rolling a shade straight. Watch the end of the roller as you roll up shade to see if shade is going even.

### Adjusting the Cord Loop

The up and down limits on your clutch operated roller shade have been set at the factory, however, if the chain stop on the shade will not allow the shade to raise or lower all the way, an adjustment on the shade will need to be made.

If the shade will not raise all the way up due to the chain stop, take the shade out of the brackets and roll up the shade by hand and replace in brackets. The shade will now raise all the way.

If the shade will not lower all the way down due to the chain stop, take the shade out of the brackets and unroll the shade to the desired position. Place the shade into the brackets. The shade will now lower all the way.

### Wrinkled Shade

Light wrinkles in a shade can be removed by lowering the shade and leaving in this position for five to seven days. The wrinkles will smooth out from the warmth of the sun.

## Care and Cleaning

### Shades of Elegance™:

We suggest periodic vacuuming with a soft brush attachment. Wet cleaning of any shade is highly discouraged, especially those with cotton content.

### Siesta Mylar Shades:

Clean mylar shades using a soft cloth that will not scratch the surface. Special care should be taken to not dent or wrinkle the shade.

## Warning

Young children can **STRANGLE** in cord and bead chain loops. They can also wrap cords around their necks and STRANGLE.



- Always keep cords and bead chains out of children's reach.
- Move cribs, playpens, and other furniture away from cords and bead chains. Children can climb furniture to get to cords.
- Do not tie cords together. Make sure cords do not twist together and create a loop.
- Attach tension device to wall or floor. This can prevent children from pulling cords and bead chains around their necks. Fasteners provided with the tension device may not be appropriate for all mounting surfaces. Use appropriate anchors for the mounting surface conditions.
- Do not remove looped cord from cord shroud.

## Limited Lifetime Guarantee

**Horizons Window Fashions warrants that its Horizons products—properly installed in a residential dwelling—will be free from defects in materials and workmanship for as long as the original purchaser owns the product.**

All fabric colors tend to lose their original intensity over time, and pull cords eventually wear out. This is considered normal wear and tear and is not covered by this guarantee. Abuse and misuse are not covered. Color lots vary and may not exactly match a previously ordered product. Repair is the purchaser's sole remedy under this guarantee.

**This guarantee does not cover incidental or consequential damages, freight, installation, or service calls (trip charges).**

## Installation Instructions for Easy Stop™ Roller Shades



Congratulations on  
the purchase of your new  
Horizons Easy Stop™ Roller Shade!

### If your shade was ordered without a valance, please proceed to Step 1.

When your Easy Stop Roller Shade is ordered with a valance it comes from the workroom with the brackets and shade mounted to the valance headrail. Remove the shade from the brackets by pushing forward on the front of the Easy Stop headrail then pulling down on the back of the headrail. Mount the valance with the provided "L" Brackets for Outside Mount or 2" screws for Inside Mount. Then reattach the shade to the brackets using Step 2, Inside Mount instructions.

### Step 1: Mount the Brackets

#### Outside Mount:

Install the appropriate number of wall brackets with the clear tension tab at the bottom of the bracket. This allows for easy removal of the shade.

The brackets should be installed with flat head screws provided.

Care should be taken to ensure all brackets are level.

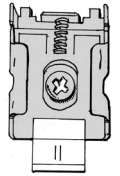

#### Inside Mount:

Install the appropriate number of brackets with the clear tension tab at the front of the bracket. This allows for easy removal of the shade.

The brackets should be installed with the flat head screws provided.

Care should be taken to ensure all brackets are installed at the same depth.

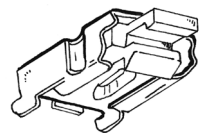

### Step 2: Mount the Headrail

#### Outside Mount:

Place the top of the headrail into the top of the bracket then push the shade forward to snap into the headrail.

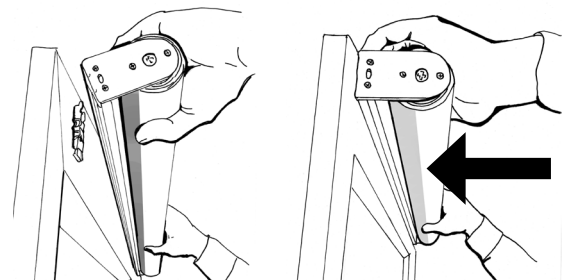

## Step 2: Mount the Headrail - Continued

### Inside Mount:

Place the rear of the headrail into the rear of the bracket then push the shade up to snap into the headrail.

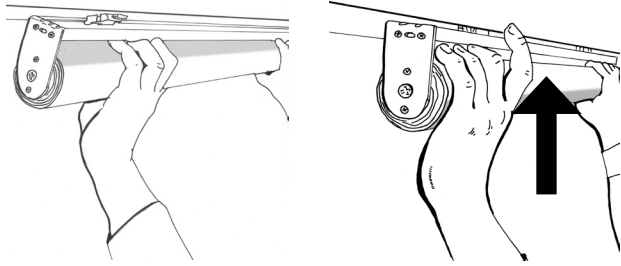

## Adjusting Tension

Adjust or set the tension by turning the LEFT Side Adjust bracket clockwise (tighter) with a standard screwdriver. It is recommended to make only ¼ to ½ turns until the desired tension is reached.

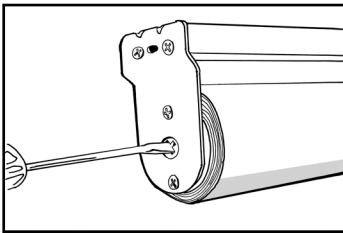

**IMPORTANT:** Be sure to use a Standard (Flat Head) screwdriver as a Phillips Head can strip the plastic adjustment screw.

## Adjusting the Stop

Set the stop device to the desired stop point by using a standard screwdriver on the RIGHT Side Adjust bracket.

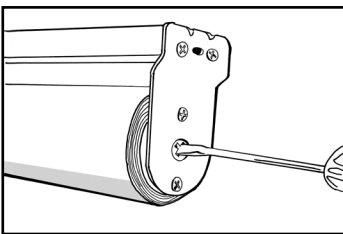

**IMPORTANT:** Be sure to use a Standard (Flat Head) screwdriver as a Phillips Head can strip the plastic adjustment screw.

## Care and Cleaning

We suggest periodic vacuuming with a soft brush attachment. Wet cleaning of any shade is highly discouraged, especially those with cotton content.

## Shade Maintenance

### Leveling a Crooked Shade

1. Pull down shade until roller is exposed. Do not pull further to avoid pulling cloth off roller.
2. Stick a 5" strip of masking tape into the roller at opposite side from where it is going crooked. Place as close to edge as possible.
3. Roll up shade. If it is still going crooked:
  - A. If shade is still crooked to the same side, add another strip of tape on top of the first one and repeat.
  - B. If shade is crooked to the opposite end, tear off about 1" from tape and repeat

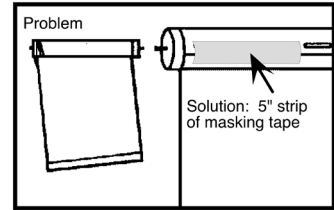

**REMEMBER:** After making above correction, your hand is still the best guide to rolling a shade straight. Watch the end of the roller as you roll up shade to see if shade is going even.

### Wrinkled Shade

We suggest periodic vacuuming with a soft brush attachment. Wet cleaning of any shade is highly discouraged, especially those with cotton content.

## Limited Lifetime Guarantee

**Horizons Window Fashions warrants that its Horizons products—properly installed in a residential dwelling—will be free from defects in materials and workmanship for as long as the original purchaser owns the product.**

All fabric colors tend to lose their original intensity over time, and pull cords eventually wear out. This is considered normal wear and tear and is not covered by this guarantee. Abuse and misuse are not covered. Color lots vary and may not exactly match a previously ordered product. Repair is the purchaser's sole remedy under this guarantee.

**This guarantee does not cover incidental or consequential damages, freight, installation, or service calls (trip charges).**

**HORIZONS™**

STYLE THAT MAKES A STATEMENT

[www.horizonshades.com](http://www.horizonshades.com)

## Warning

Young children can **STRANGLE** in cord and bead chain loops. They can also wrap cords around their necks and STRANGLE.



- Always keep cords and bead chains out of children's reach.
- Move cribs, playpens, and other furniture away from cords and bead chains. Children can climb furniture to get to cords.
- Do not tie cords together. Make sure cords do not twist together and create a loop.
- Attach tension device to wall or floor. This can prevent children from pulling cords and bead chains around their necks. Fasteners provided with the tension device may not be appropriate for all mounting surfaces. Use appropriate anchors for the mounting surface conditions.
- Do not remove looped cord from cord shroud.

## Limited Lifetime Guarantee

**Horizons Window Fashions warrants that its Horizons products—properly installed in a residential dwelling—will be free from defects in materials and workmanship for as long as the original purchaser owns the product.**

All fabric colors tend to lose their original intensity over time, and pull cords eventually wear out. This is considered normal wear and tear and is not covered by this guarantee. Abuse and misuse are not covered. Color lots vary and may not exactly match a previously ordered product. Repair is the purchaser's sole remedy under this guarantee.

**This guarantee does not cover incidental or consequential damages, freight, installation, or service calls (trip charges).**