

HORIZONS[®]

WINDOW FASHIONS



DECORATIVE HARDWARE COLLECTION

See What's New

Wood Finials
See Pages E3-E10

Treasures Collection
See Pages E11-E14

PHOTO GALLERY



Page E3

Fortunato **NEW**

1 3/8" Wood Pole Collection

- The elegant look of hand carved wood
- Fluted or smooth poles
- Nine unique hand painted finial styles
- Seven color options in each style
- Custom cut to your window's exact size
- Coordinating rings, tie-backs, and swag holders



Page E7

Fortunato **NEW**

2" Wood Pole Collection

- A larger, more impressive alternative to 1 3/8" poles
- Fluted or smooth poles
- Nine unique hand painted finial styles
- Seven color options in each style
- Custom cut to your window's exact size
- Coordinating rings, tie-backs, and swag holders



Page E11

Treasures **NEW**

1 1/2" Metal Rod Collection

- Fine crafted metal workmanship
- Six unique finials
- Four finishes
- Custom cut to your window's exact size
- Coordinating rings and brackets
- By-pass Rings and Brackets
- Traverse Rods

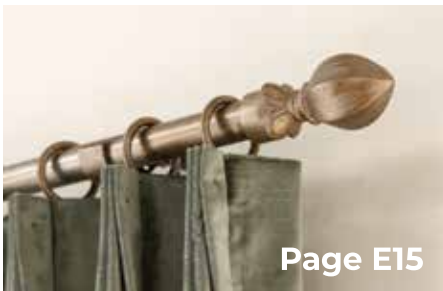

Page E15

Iron Essence & Finesse

1" Metal Rod Collection

- Fine crafted metal workmanship
- Seven unique Iron Essence finials
- Six Iron Essence finishes
- Custom cut to your window's exact size
- Coordinating rings, tie-backs, and brackets

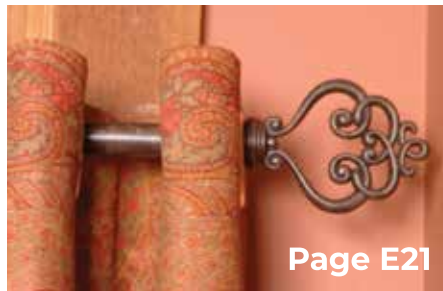

Page E21

Bellissima

3/4" Metal Rod Collection

- Fine crafted metal workmanship
- Eight unique finial styles
- Five color options in each style
- Custom cut to your window's exact size
- Coordinating rings, tie-backs, and swag holders

NEW

Fortunato

1 3/8" Wood Pole Collection

Complete pole sets include finials, brackets, and a 1 3/8" diameter wood pole custom cut to your exact size!

Great accessories like tie-backs, rings, and extension brackets are also offered.

PHOTO GALLERY

Fortunato

1 3/8" Wood Pole Collection

1 3/8" Diameter Poles, Finials, and Accessories
Set Includes: Custom Pole, Finials, and Hardware



ALASSIO
5 1/8" W x 2 3/4" H
Shown in White

BERGAMO
3 5/8" W x 2" H
Shown in
Antique Silver



CONICO
3 1/4" W x 2 3/4" H
Shown in Antique Gold

ACCESSORIES

See Product Information section
for more details.



Poles Only (Smooth and Fluted)
Available in custom lengths up to 192".
Poles over 96" will have a splice.

A.



B.



Brackets

A. Standard Bracket
2 3/4" wall-to-pole clearance
Height: 3 3/4"

B. Extension Bracket
5 1/2" wall-to-pole clearance
Height: 4"



1" Ring
1 3/4" ID x 2 3/4" OD

ACCESSORIES

See Product Information section for more details.



Trieste Tie Back
4 1/8" L x 4 1/8" W



Firenze Tie Back
4 3/4" L x 4 3/4" W



Adjustable Corner Connector
2 1/2" L x 2 1/2" L x 1 3/4" W

Fortunato

1 3/8" Wood Pole Collection

1 3/8" Diameter Poles, Finials, and Accessories
Set Includes: Custom Pole, Finials, and Hardware

CUNEO
4 3/8" W x 2 1/2" H
Shown in Walnut



DIAMANTE
3 5/8" W x 2 1/2" H
Shown in
Antique White

END CAP (1 3/8")
5/8" W x 2 1/8" H
Shown in Black



FINISHES



White

Antique
White

Antique
Silver

Antique
Gold

Dark
Cherry

Walnut

Black

Fortunato

1 3/8" Wood Pole Collection

1 3/8" Diameter Poles, Finials, and Accessories
Set Includes: Custom Pole, Finials, and Hardware



MAISON
3" W x 2 7/8" H
Shown in Antique White



MILANO
4" W x 2 1/2" H
Shown in Dark Cherry



PALLA
3 3/4" W x 2 5/8" H
Shown in Walnut



WHITE



ANTIQUE SILVER



ANTIQUE WHITE



ANTIQUE GOLD



DARK CHERRY



WALNUT



BLACK

NEW

Fortunato

2" Wood Pole
Collection

Complete pole sets include finials, brackets, and a 2" diameter wood pole custom cut to your exact size!

Great accessories like tie-backs, rings, and extension brackets are also offered.

PHOTO GALLERY

Fortunato

2" Wood Pole Collection

2" Diameter Poles, Finials, and Accessories
Set Includes: Custom Pole, Finials, and Hardware



BARI
6" W x 3½" H
Shown in
Dark Cherry

CAGLIARI
5¾" W x 3¼" H
Shown in
Antique Silver



END CAP (2")
¾" W x 2¾" H
Shown in Antique Gold

FINISHES



White Antique White Antique Silver Antique Gold Walnut Dark Cherry Black

ACCESSORIES

See Product Information section
for more details.



Poles Only (Smooth and Fluted)
Available in custom lengths up to 192".
Poles over 96" will have a splice.

A.



B.

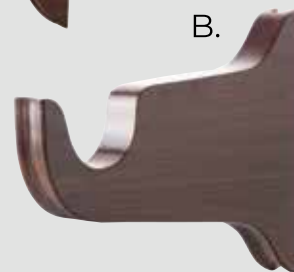

Brackets

- A. Standard Bracket
3" wall-to-pole clearance
Height: 7⅝"
- B. Extension Bracket
6" wall-to-pole clearance
Height: 6⅝"



2" Ring
2⅝" ID x 3⅝" OD

ACCESSORIES

See Product Information section
for more details.



Trieste Tie Back
4 $\frac{1}{8}$ " L x 4 $\frac{1}{8}$ " W



Firenze Tie Back
4 $\frac{3}{4}$ " L x 4 $\frac{3}{4}$ " W



**Adjustable Corner
Connector**
2 $\frac{1}{2}$ " L x 2 $\frac{1}{2}$ " L x 1 $\frac{3}{4}$ " W

Fortunato

2" Wood Pole Collection

2" Diameter Poles, Finials, and Accessories
Set Includes: Custom Pole, Finials, and Hardware



ERMONT
4 $\frac{3}{4}$ " W x 3 $\frac{1}{4}$ " H
Shown in Black



MISSIONE
3 $\frac{3}{4}$ " W x 3 $\frac{5}{8}$ " H
Shown in Walnut



NAPOLI
5 $\frac{1}{2}$ " W x 2 $\frac{5}{8}$ " H
Shown in White

Fortunato

2" Wood Pole Collection

2" Diameter Poles, Finials, and Accessories
Set Includes: Custom Pole, Finials, and Hardware



RIMINI
5" W x 3" H
Shown in Antique Silver



TONDO
4¾" W x 3½" H
Shown in Antique White



VITTORIA
3¾" W x 3½" H
Shown in Walnut

WHITE

ANTIQUE SILVER

ANTIQUE WHITE

ANTIQUE GOLD

DARK CHERRY

WALNUT

BLACK

NEW

Treasures

1½" Metal
Collection

This *NEW* contemporary line of drapery rods and exquisite finials is available in four modern finishes. Available as inside, outside, or even ceiling mounts, this beautiful collection is also ideal for bay and corner applications.

PHOTO GALLERY

Treasures

Metal Collection

1½" Diameter Poles, Finials, and Accessories
Set Includes: Custom Pole, Finials, and Hardware

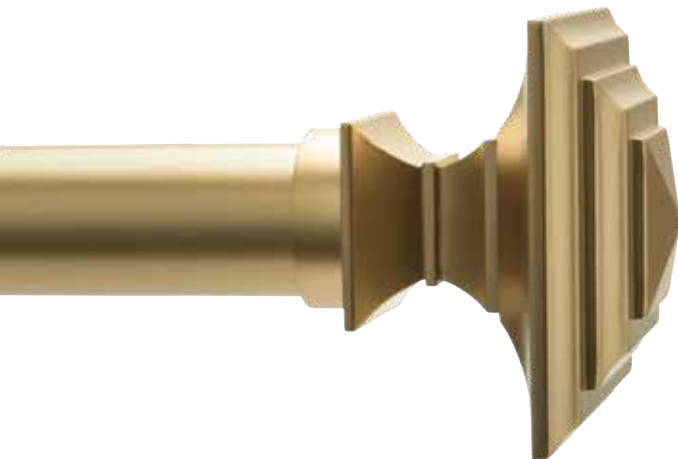

KINGSTON
3½" W x 3¾" H
Shown in Matte Gold



CAY
3⅝" W x 3⅜" H
Shown in Black



MAYA
1" W x 2¼" H
Shown in Oil Rubbed Bronze

ACCESSORIES



Easy Glide Rings With Eyelet
1⅞" ID x 2⅜" OD



By-Pass Rings With Eyelet
2⅞" ID x 2¾" OD



Adjustable Single Bracket
3½" Length
Projection: 4¼ - 5¼" (wall to center of rod)



Adjustable Double Bracket
3½" Length
Front Projection: 6⅝ - 8" (wall to center of rod)
Back Projection: 4 - 5⅞" (wall to center of rod)



By-Pass Bracket
1⅞" Length
Projection: 4¼" (wall to center of rod)



Inside Mount Bracket
1⅞" L x 2" W



Splice

Treasures

Metal Collection

1½" Diameter Poles, Finials, and Accessories
Set Includes: Custom Pole, Finials, and Hardware

ACCESSORIES



Enclosed Ceiling Mount Bracket
2" Width

Projection: 2¼" Ceiling to center of rod



Enclosed Single Bracket
2½" Length

Projection: 4" Wall to center of rod

Elbow
2" x 2"



BRUSHED NICKEL

MATTE GOLD

OIL RUBBED BRONZE

BLACK

Finishes Available/Poles Only

Available in custom lengths up to 192".
Poles over 96" will have a splice.

LUCIA
4¾" W x 3⅛" H
Shown in
Brushed Nickel



ANTIGUA
3⅝" W x 2⅞" H
Shown in Matte Gold



BONAIRE
3⅝" W x 2⅝" H
Shown in Oil
Rubbed Bronze



Treasures

Traverse Systems, Cord Free Baton Draw

1½" Diameter Poles, Finials, and Accessories
Set Includes: Custom Pole, Finials, and Hardware



TRAVERSE POLE SET
Shown in Oil Rubbed Bronze



RIPPLEFOLD POLE SET
Shown in Black

ACCESSORIES



Traverse System
Wall Bracket
3 7/8" x 2"



Traverse System
Ceiling Bracket
2 1/4" x 5/8"

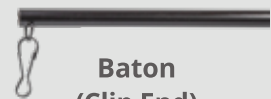

Baton
(Clip End)
39 1/2" L



Baton
(Handle)

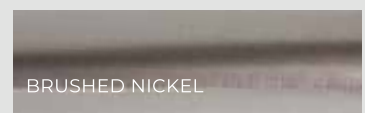

BRUSHED NICKEL

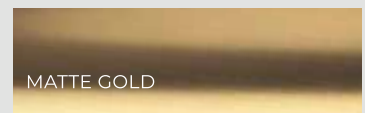

MATTE GOLD

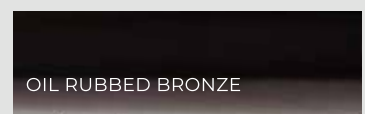

OIL RUBBED BRONZE

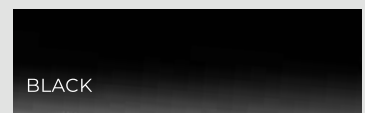

BLACK

Finishes Available/Poles Only

Available in custom lengths
upto 192". Poles over 96"
will have a splice.

Iron Essence & Finesse

Metal Collection



With the enduring look of hand-forged iron, this collection's classic style engages handsomely with a wide range of decors. The Iron Essence line offers six finishes in custom widths, and includes bay and corner applications. Layered treatments are easily achieved through the use of an optional double bracket.

PHOTO GALLERY

Iron Essence

Collection

1" Diameter Poles, Finials, and Accessories
Set Includes: Custom Pole, Finials, and Hardware



BECKTON
4½" W x 1⅞" H
Shown in
Vintage Gold

LAMBETH
3½" W x 2" H
Shown in
Golden Silver



EXFORD
3½" W x 2" H
Shown in Black

PENRITH
2¾" W x 2½" H
Shown in Bronze



ACCESSORIES



Poles Only
Available in custom lengths
up to 192". Poles over 144" will
have a splice.



Ring Clip
1½" ID x 2" OD
Hang: 2½"



Eyelet Ring
1½" IN x 2" OD
Hang: 2¼"

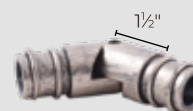

**Adjustable Corner
Connector**
1½" L x 1½" L



Inside Bracket
1" L x 1⅞" W

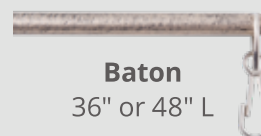

Baton
36" or 48" L

Iron Essence Collection

1" Diameter Poles, Finials, and Accessories
Set Includes: Custom Pole, Finials, and Hardware

ACCESSORIES



Bracket
3 1/8" H x 3 3/8" L
2" wall-to-pole clearance.



Extension Bracket
3 1/8" H x 6" L
5" wall-to-pole clearance.



Double Bracket
3" H x 6 1/8" L
2" & 5" wall-to-pole clearance.



Adjustable Bracket
3 1/4" - 5 3/4" wall-to-pole clearance.



Ceiling or Wall Bracket
3" H x 2 1/8" L
1" wall-to-pole clearance.



Splicer



ELTHAM
5 7/8" W x 4 3/8" H
Shown in Black



WHITTON
1 1/8" W x 1 3/8" H
Shown in Golden Bronze



WRESSEL
4 3/4" W x 3 1/4" H
Shown in Aged Pewter

FINISHES



GOLDEN SILVER



AGED PEWTER



VINTAGE GOLD



GOLDEN BRONZE



BRONZE



BLACK

HORIZONS | DECORATIVE HARDWARE

E17

Finesse

Collection

1" Diameter Poles, Finials, and Accessories



CYLINDER

3¼" W x 1⅞" H

Shown in Satin Brass

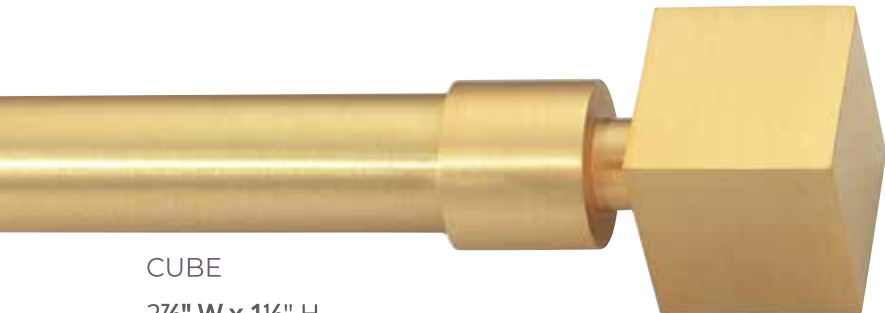

CUBE

2⅞" W x 1½" H

Shown in Satin Brass



END CAP

⅞" W x 1⅞" H

Shown in Brushed Nickel



SPHERE

3" W x 2" H

Shown in Brushed Nickel

ACCESSORIES



Eyelet Ring

1⅞" ID x 1¾" OD

Hang: 2⅛"



Adjustable Corner Connector

2⅛" L x 2⅛" L



Inside Bracket

¾" L x 1⅛" W



Standard Bracket

4⅞" L x 2⅞" W

3" wall-to-pole clearance.



Extension Bracket

6⅞" L x 2⅞" W

6" wall-to-pole clearance.

FINISHES



Brushed Nickel



Satin Brass

ACCESSORIES



Wall or Ceiling Bracket
3 7/8" L x 2" W
2 3/4" wall to pole
clearance.

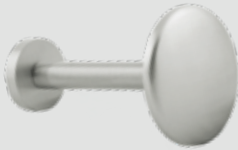

Disc Holdback
4" L x 2 1/4" W
Diameter 2 1/4"



Poles Only

Available in custom lengths
up to 192". Poles over 96" will
have a splice.



Splicer

Finesse Collection

1" Diameter Poles, Finials, and Accessories



CONE

3 1/2" W x 1 1/2" H
Shown in Satin Brass



CLEAR SPHERE

3 3/4" W x 2 1/4" H
Shown in Brushed Nickel



Finesse Pole with Finial: Sphere
Finish: Brushed Nickel



Bellissima

3/4" Metal Pole
Collection



Complete rod sets include finials, brackets, and a 3/4" metal rod custom cut to your exact size!

Great accessories like tie-backs, rings, and extension brackets are also offered.



Bellissima

Collection

¾" Diameter Poles, Finials, and Accessories

ANCONA
4" W x 1½" H
Shown in
Ivory Gold



CESENA
6" W x 2¼" H
Shown in
Rustic



CORTONA
4¼" W x 2½" H
Shown in Black



GENOVA
6" W x 3¾" H
Shown in Copper



ACCESSORIES

See Product Information section
for more details.



Poles Only

Available in custom lengths up to 192". Copper and Satin poles over 72" will come as two pieces with a splice. Black, Ivory Gold, and Rustic over 144" will also be spliced.



Ring Clip
1¼" ID x 1½" OD



Ring Hook
1¼" ID x 1½" OD



Corner Connector
¾" L x ¾" L
Adjusts from 90° to 180°



Splicer

Bellissima

Collection

¾" Diameter Poles, Finials, and Accessories

ACCESSORIES

See Product Information section for more details.



Adjustable Bracket
3 ½" - 5 ½" wall to pole clearance.



Calabria Tie Back
4 ⅝" L x 2 ½" W
Diameter 2 1/8"



Lucca Tie Back
5 ¾" L x 2 ¾" W
Diameter 2 ¾"



Siena Tie Back
5 ½" W x 3 ½" L



NOVARA
3" W x 2" H
Shown in Satin



PISA
4 ¼" W x 3 ⅝" H
Shown in Ivory Gold



ROMA
4 ¾" W x 1 ¾" H
Shown in Rustic



PERUGIA
3 ⅞" W x 2 ½" H
Shown in Black

FINISHES



Ivory Gold



Satin



Copper



Rustic



Black

Decorative Hardware Collection

Product Information

INDEX

1-3/8" Fortunato Wood Collection	Page E28	NEW
2" Fortunato Wood Collection	Page E30	NEW
Fortunato Decorative Traverse Rods	Page E32	
1-1/2" Treasures Collection	Page E34	NEW
1" Iron Essence Rod Collection	Page E38	
Finesse Rod Collection	Page E40	
3/4" Bellissima Rod Collection	Page E42	

HORIZONS[®]
WINDOW FASHIONS

1-3/8" Fortunato NEW Collection



E28

Adjustable corner connectors are perfect for any angle.

Measuring Terms

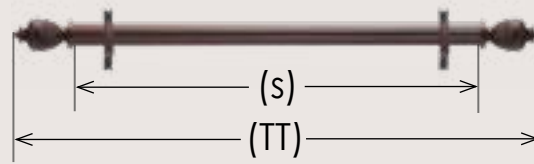

STANDARD - POLE WIDTH (S) is the exact size of the pole alone. Specify "S" when ordering.

TIP-TO-TIP (TT) is the size of the entire unit including the finials. Specify "TT" when ordering.

March 2019

1-3/8" Fortunato Collection Specifications & Options

1-3/8" Fortunato Sets

Fortunato Poles are custom cut to the exact size ordered and come complete with the pole, finials, brackets and screws.

Poles, finials and brackets may also be purchased separately.

Bracket Sizes

Each set includes standard brackets. Extension brackets may be substituted at the surcharge in the price list on page E25.

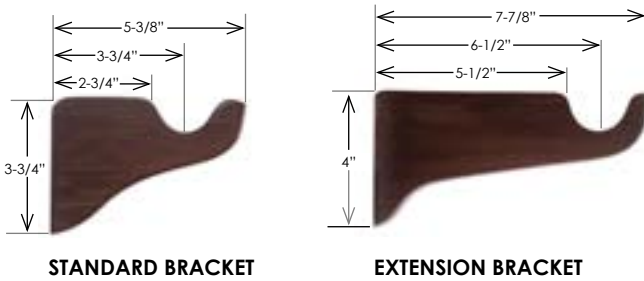

STANDARD BRACKET

EXTENSION BRACKET

Pole Styles

1-3/8" poles are available in Fluted and Smooth styles. Please specify pole style when ordering.



FLUTED POLE



SMOOTH POLE

Spliced Poles

All poles over 96" will come as two pieces with a splice. The splice will be at the center of the pole and is concealed and supported by the center bracket.

Bracket Counts

Each set comes with the following number of brackets based on width. Additional brackets are available.

WIDTHS TO:	# BRACKETS:
48"	2
72"	3
96"	4
144"	5
192"	7

Construction Information

The poles, rings and brackets are made from poplar wood. The finials and tie-backs are resin casts of hand-carved wooden originals.

March 2019

Accessories

Rings, tie-backs and adjustable corner connectors are priced per item and ordered separately from the sets.



4-1/8"

TRIESTE TIE BACK/
SWAG HOLDER



4-3/4"

4-3/4"

FIRENZE TIE BACK/
SWAG HOLDER

Note: Firenze and Trieste include adjustable brackets that allow projections from 2-7/8" to 4".

ADJUSTABLE CORNER
CONNECTOR



RING

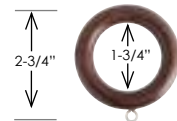

Wood Rings with brass clips attached are available upon request. Please specify when ordering.

Finial Specifications

STYLE	WIDTH	HEIGHT
 Alassio	5-1/8"	2-3/4"
 Bergamo	3-5/8"	2"
 Conico	3-1/4"	2-3/4"
 Cuneo	4-3/8"	2-1/2"
 Diamante	3-5/8"	2-1/2"
 End Cap	5/8"	2-1/8"
 Maison	3"	2-7/8"
 Milano	4"	2-1/2"
 Palla	3-3/4"	2-5/8"

HORIZONS[®]
WINDOW FASHIONS

2" Fortunato Collection

NEW



Adjustable corner connectors are perfect for any angle.

E30

Measuring Terms

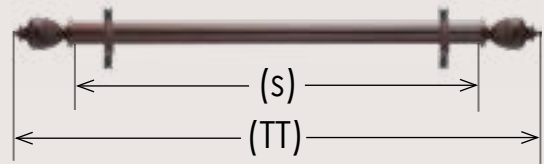

STANDARD - POLE WIDTH (S) is the exact size of the pole alone. Specify "S" when ordering.

TIP-TO-TIP (TT) is the size of the entire unit including the finials. Specify "TT" when ordering.

March 2019

2" Fortunato Collection Specifications & Options

2" Fortunato Sets

Fortunato Poles are custom cut to the exact size ordered and come complete with the pole, finials, brackets and screws.

Poles, finials and brackets may also be purchased separately.

Bracket Sizes

Each set includes standard brackets. Extension brackets may be substituted at the surcharge in the price list on page E25.

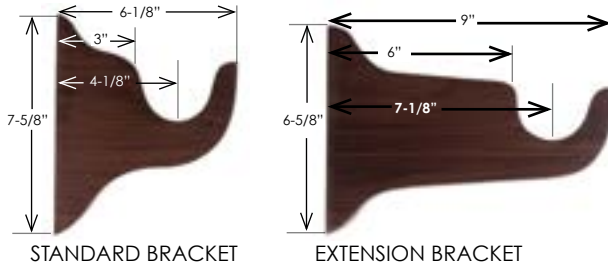

Pole Styles

2" poles are available in Fluted and Smooth styles. Please specify pole style when ordering.



FLUTED POLE

SMOOTH POLE

Spliced Poles

All poles over 96" will come as two pieces with a splice. The splice will be at the center of the pole and is concealed and supported by the center bracket.

Bracket Counts

Each set comes with the following number of brackets based on width. Additional brackets are available.

WIDTHS TO:	# BRACKETS:
48"	2
72"	3
96"	4
144"	5
192"	7

Construction Information

The poles, rings and brackets are made from poplar wood. The finials and tie-backs are resin casts of hand-carved wooden originals.

Accessories

Rings, tie-backs and adjustable corner connectors are priced per item and ordered separately from the sets.



**TRIESTE TIE BACK/
SWAG HOLDER**

**FIRENZE TIE BACK/
SWAG HOLDER**

Note: Firenze and Trieste include adjustable brackets that allow projections from 2-7/8" to 4".

**ADJUSTABLE CORNER
CONNECTOR**



Wood Rings with brass clips attached are available upon request. Please specify when ordering.

Finial Specifications

	STYLE	WIDTH	HEIGHT
	Bari	6"	3-1/2"
	Cagliari	5-3/4"	3-1/4"
	End Cap (2")	3/4"	2-3/4"
	Ermont	4-3/4"	3-1/4"
	Missione	3-3/4"	3-5/8"
	Napoli	5-1/2"	2-5/8"
	Rimini	5"	3"
	Tondo	4-3/4"	3-1/2"
	Vittoria	3-7/8"	3-1/2"

HORIZONS[®]
WINDOW FASHIONS

Fortunato Decorative Traverse Rods

Decorative Traverse Rods Specifications & Options

Decorative Traverse Rods

Horizons Decorative Traverse Rods are drapery traverse rods with a decorative 2" wood fascia attached. They are custom cut to the exact size ordered and include a single or double traverse rod, finials, returns, end caps, brackets and screws. They are available in all the styles and colors of the 2" Wood Collections on pages E7-E10.

Size Limitations

Max Width:	188"
Max Width without decorative splice:	92"
Minimum Width:	30"

Note: The ordered width of the Decorative Traverse Rod should equal the drapery width. See Return or Finial sections on this page to determine the actual rod width.

Spliced Rods

All rods over 92" are constructed as two pieces with a 3/4" capped decorative splice.

Note: If smaller rods are mounted in the same room, a decorative splice may be ordered to match the larger rod's appearance at no extra charge.



IM Deductions

The workroom will deduct 1/4" from the width of the decorative traverse rod when mounted between two walls. The ends of the rod will include 3/4" color-coordinating wood caps.



Wall Mount Only

Decorative Traverse Rods are not available as ceiling mounts and require 1-7/8" of mounting surface above the window opening.

Pin Settings

Recommended Pin Settings for Draperies with a Decorative Traverse Rod:

Single Traverse Rod	1/2"
Double Traverse Rod (over)	1/2"
Double Traverse Rod (under)	1-1/2"

Double Traverse Rods

When a double Traverse rod is ordered, only the front rod will be covered with the decorative fascia. There is no extra charge for a double rod.

Under Treatments

We recommend the Pinch Pleat style for the under treatment when ordering a double Decorative Traverse Rod. Indicate on the Drapery order form that the drape is an under treatment. The workroom will adjust the height so the under treatment covers the back rod and is 1/2" shorter than the front drape (or over treatment).

Dust Cover

Horizons Decorative Traverse Rods are constructed with a 3" color coordinated dust cap.



Returns

Returns with color-coordinating 3/4" wood caps are available in place of finials at no extra charge.



Recommended Return Sizes for Draperies with a Decorative Traverse Rod:

Single traverse rod	3-1/2" returns
Double traverse rod (over)	6" returns
Double traverse rod (under)	1" returns

PROJECTION

Standard projections (from wall to face of the rod) for Decorative Traverse Rods are:

Single traverse rod	4-3/4" returns
Double traverse rod (over)	7" returns

WOOD CAP SIZE CONSIDERATIONS

When ordering the width of a Decorative Traverse Rod with returns consider the Wood Cap will extend beyond the width of the drape by 3/4".

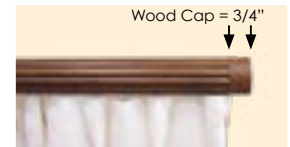

Finials

Horizons Decorative Traverse Rods available in all the styles and colors of the 2" Wood Collections on pages E8-E10.

FINIAL SIZE CONSIDERATIONS

The finial will extend beyond the end of the drapery by 1-3/4" plus the finial width. For Finial dimensions see pages E31.

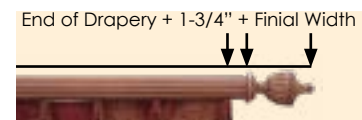

HORIZONS[®]
WINDOW FASHIONS

1-1/2" Treasures Collection

NEW

E34

March 2019

1-1/2" Treasures Collection Specifications & Options

1-1/2" Treasures Collection Sets

Treasures poles are custom cut to the exact size ordered and come complete with the rod, finials, brackets and screws.

Rods, finials and brackets may also be purchased separately.

Bracket Sizes

Each set includes adjustable single brackets standard.



ADJUSTABLE SINGLE BRACKET



ADJUSTABLE DOUBLE BRACKET



ENCLOSED BRACKET



BY-PASS BRACKET



CEILING MOUNT BRACKET



INSIDE MOUNT BRACKET

Spliced Rods

Black, Oil Rubbed Bronze and Matte Gold rods over 144" will come as two pieces with a splice. Brushed Nickel poles over 120" will come as two pieces with a splice.

Bracket Counts

Each set comes with the following number of brackets based on width. Additional brackets are available.

WIDTHS TO:	# BRACKETS:
48"	2
72"	3
96"	4
144"	5
192"	7

Measuring Terms

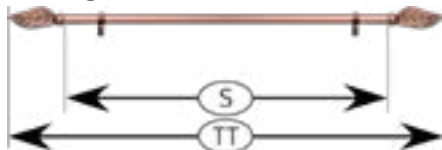

STANDARD - POLE WIDTH (S) is the exact size of the pole alone. Specify "S" when ordering.

TIP-TO-TIP (TT) is the size of the entire unit including the finials. Specify "TT" when ordering.

Accessories

Rings, tie-backs and adjustable corner connectors are priced per item and ordered separately from the sets.



EYELET RING
1-7/8" ID X 2-3/8" OD
Pin Setting 1"



BY-PASS RING
2-1/8" ID X 2-3/4" OD
Use with By-pass brackets
Pin Setting 1-1/4"



ELBOW
2" X 2"
Adjustable from 90° to 180°.



BATON
39-1/2" L

Construction Information

The poles, finials, rings and brackets are made from Aluminum, Steel or Zinc.

Finial Specifications

	STYLE	WIDTH	HEIGHT
	Antigua	3-3/8"	2-7/8"
	Bonaire	3-3/8"	2-5/8"
	Cay	3-5/16"	3-1/8"
	Kingston	3-1/2"	3-7/8"
	Lucia	4-3/4"	3-1/8"
	Maya	1"	2-1/4"

HORIZONS[®]
WINDOW FASHIONS

Treasures Traverse System

NEW



Treasures Traverse Rod Split Draw for Pleated Drapery



Treasures Traverse Rod Split Draw for Ripplefold Drapery

E36

March 2019

Treasures Traverse System Specifications & Options

Treasures Traverse System

Treasures Traverse Rods are cord free baton draw 1-1/2" rods available for Pleated or Ripplefold drapery. They are custom cut to the exact size ordered and include a channel track, finials, brackets and screws. They are available in all the styles and colors of the Treasures Collection.

Bracket Sizes

Each set includes brackets.



Bracket Counts

Each set comes with the following number of brackets based on width. Additional brackets are available.

WIDTHS TO:	# BRACKETS:
48"	2
72"	3
96"	4
144"	5
192"	7

Size Limitations

Max Width:	192"
Max Width without splice:	96"
Minimum Width:	18"

Note: The ordered width of the Decorative Traverse Rod should equal the drapery width. See Finial specifications on this page to determine the total width.

Traverse System Options

- One-way or split draw are available.
- Baton draw only.
- Available for pleated or Ripplefold drapery.

Ripplefold Options

- Available for Ripplefold Drapery at 80%, 100% or 120% fullness.
- Available as overlap or butting.

Pin Settings

Recommended Pin Setting for pleated draperies with a Treasures Traverse Rod is 3/4".

Baton

The Treasures Traverse rods come standard with a clear acrylic baton available at 36", 48", 60" length. Please specify height when ordering.

Metal Batons in the same finish as the track may be ordered as an extra charge option. They are only available at 39-1/2" in length.



Finial Specifications

	STYLE	WIDTH	HEIGHT
	Antigua	3-3/8"	2-7/8"
	Bonaire	3-3/8"	2-5/8"
	Cay	3-5/16"	3-1/8"
	Kingston	3-1/2"	3-7/8"
	Lucia	4-3/4"	3-1/8"
	Maya	1"	2-1/4"



1” Iron Essence Collection

E38

March 2019

1" Iron Essence Collection Specifications & Options

1" Iron Essence Sets

Iron Essence poles are custom cut to the exact size ordered and come complete with the rod, finials, brackets and screws.

Rods, finials and brackets may also be purchased separately.

Bracket Sizes

Each set includes standard brackets.

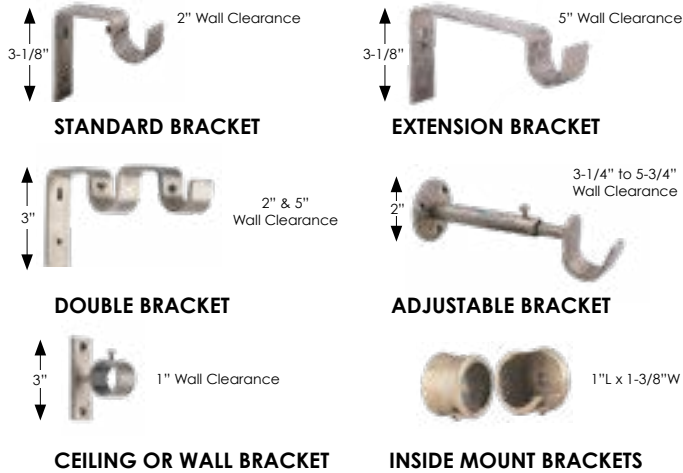

Spliced Rods

All over 144" will come as two pieces with a splice.

Bracket Counts

Each set comes with the following number of brackets based on width. Additional brackets are available.

WIDTHS TO:	# BRACKETS:
48"	2
72"	3
96"	4
144"	5
192"	7

Measuring Terms

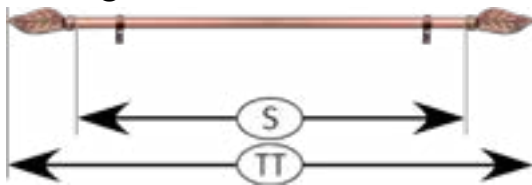

STANDARD - POLE WIDTH (S) is the exact size of the pole alone. Specify "S" when ordering.

TIP-TO-TIP (TT) is the size of the entire unit including the finials. Specify "TT" when ordering.

Construction Information

The poles, finials, tie-backs, rings and brackets are made from iron.

Accessories

Rings, batons and adjustable corner connectors are priced per item and ordered separately from the sets.



RING CLIP
1-1/2" ID X 2" OD
HANG: 2-1/2"



EYELET RING
1-1/2" ID X 2" OD
HANG: 2-1/4"



ADJUSTABLE CORNER CONNECTOR

Adjustable from 90° to 180°.



BATON
36" & 48" L

Finial Specifications

STYLE	WIDTH	HEIGHT
 Beckton	4-1/2"	1-7/8"
 Eltham	5-7/8"	4-3/8"
 Exford	3-1/2"	2"
 Lambeth	3-1/2"	2"
 Penrith	2-3/4"	2-1/2"
 Whitton	1-1/8"	1-5/8"
 Wressel	4-3/4"	3-1/4"



1"
Finesse
Collection

E40

March 2019

1" Finesse Collection Specifications & Options

1" Finesse Sets

Finesse poles are custom cut to the exact size ordered and come complete with the rod, finials, brackets and screws.

Rods, finials and brackets may also be purchased separately.

Bracket Sizes

Each set includes standard brackets.

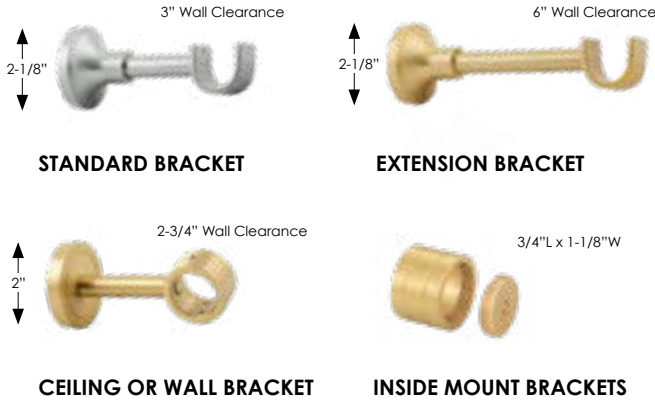

Accessories

Rings, tie-backs and adjustable corner connectors are priced per item and ordered separately from the sets.



EYELET RING
1-7/16" ID X 1-3/4" OD
HANG: 2-1/8"



ADJUSTABLE CORNER CONNECTOR



TIE BACK
4" L X 2-1/4" W
Diameter: 2-1/4"

Adjustable from 90° to 180°.

Spliced Rods

All over 96" will come as two pieces with a splice.

Bracket Counts

Each set comes with the following number of brackets based on width. Additional brackets are available.

WIDTHS TO:	# BRACKETS:
48"	2
72"	3
96"	4
144"	5
192"	7

Measuring Terms

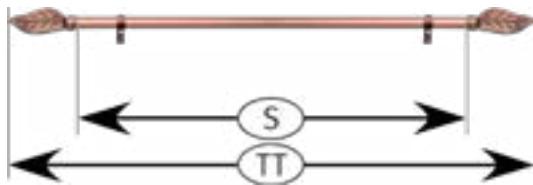

STANDARD - POLE WIDTH (S) is the exact size of the pole alone. Specify "S" when ordering.

TIP-TO-TIP (TT) is the size of the entire unit including the finials. Specify "TT" when ordering.

Construction Information

The poles, finials, tie-backs, rings and brackets are made from iron.

Finial Specifications

STYLE	WIDTH	HEIGHT
 Cone	3-1/2"	1-1/2"
 Cube	2-7/8"	1-1/2"
 Cylinder	3-1/4"	1-7/8"
 End Cap	7/8"	1-1/8"
 Sphere	3"	2"
 Clear Sphere	3-3/4"	2-1/4"

HORIZONS
WINDOW FASHIONS

3/4" Bellissima Collection



March 2019
Adjustable corner connectors are perfect for any angle.

3/4" Bellissima Collection Specifications & Options

3/4" Bellissima Sets

Bellissima poles are custom cut to the exact size ordered and come complete with the rod, finials, brackets and screws.

Rods, finials and brackets may also be purchased separately.

Bracket Sizes

Each set includes standard brackets. The brackets are adjustable and will extend the rod out 6-1/4".

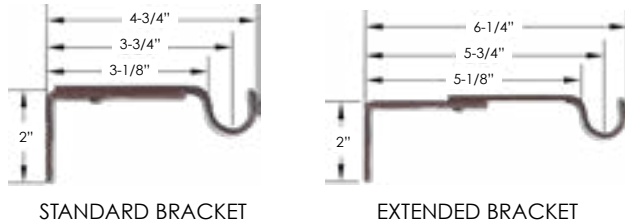

Spliced Rods

Copper and Satin rods over 72" will come as two pieces with a splice. Black, Ivory Gold and Rustic over 144" will also be spliced.

Bracket Counts

Each set comes with the following number of brackets based on width. Additional brackets are available.

WIDTHS TO:	# BRACKETS:
48"	2
72"	3
96"	4
144"	5
192"	7

Measuring Terms

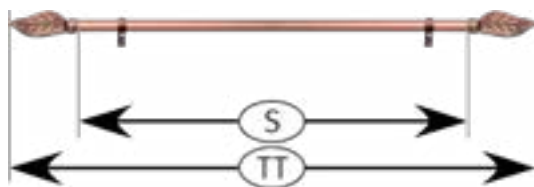

STANDARD - POLE WIDTH (S) is the exact size of the pole alone. Specify "S" when ordering.

TIP-TO-TIP (TT) is the size of the entire unit including the finials. Specify "TT" when ordering.

Construction Information

The poles, finials, tie-backs, rings and brackets are made from iron.

Accessories

Rings, tie-backs and adjustable corner connectors are priced per item and ordered separately from the sets.

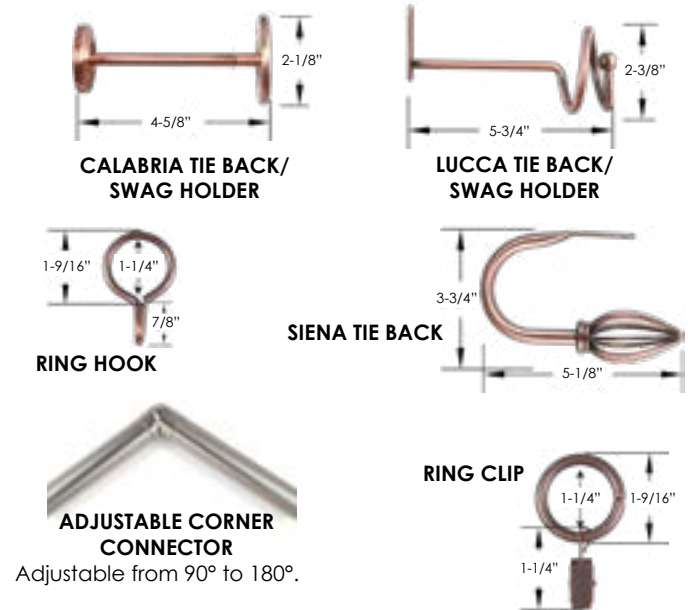

Finial Specifications

	STYLE	WIDTH	HEIGHT
	Ancona	4"	1-15/16"
	Cesena	6"	2-1/4"
	Cortona	4-1/4"	2-1/8"
	Genova	6"	3-7/8"
	Novara	3"	2"
	Perugia	3-7/8"	2-1/8"
	Pisa	4-1/4"	3-1/16"
	Roma	4-3/4"	1-3/8"

